



<http://www.adsequip.com/>

**User's Manual  
of  
Classic 200 / Beyond 400 Delievery System**

## **Copyrights**

ADS makes no warranty of any kind with regard to this material , including but not limited to, the implied warranties of merchantability and fitness for a particular purpose. ADS shall not be held liable for any errors contained herein or any consequential or other damages concerning furnishing, performance or use of this material. The information in this document is subject to change without notice . If you find any problems in the documentation, please report them to us in writing. ADS does not warrant that this document is error-free.

No part of this document may be copied, reproduced, altered, or transmitted in any form or by any means, electronic or mechanical, including photocopying, recording, or by any information storage and retrieval system, without prior written permission from ADS.

The document is intended to be used in conjunction with the equipment.

## **Comments and feedbacks**

Please contact us if you have any feedback and opinions on this document:

Add: 1590 S Milliken Ave., unit A, Ontario, CA 91761

Tel: (626) 620 0456

E-mail : [sales@adsequip.com](mailto:sales@adsequip.com)

<http://www.adsequip.com/>

## **Product service**

If you want to get service information, please contact the local dealer authorized by ADS company.

Technical support tel: 800 488 9708

# CONTENTS

<b>1</b>	<b>Introduction.....</b>	<b>1</b>
	1.1	Products information..... 1
	1.2	Symbols explanation..... 1
<b>2</b>	<b>Specifications.....</b>	<b>3</b>
<b>3</b>	<b>Application notice.....</b>	<b>3</b>
	3.1	Attentions ..... 3
	3.2	Warning information..... 5
<b>4</b>	<b>Sizes.....</b>	<b>6</b>
<b>5</b>	<b>Operations.....</b>	<b>8</b>
	5.1	Water supply system..... 8
	5.2	Assistant's control..... 9
	5.3	Dentist unit..... 10
	5.3.1	Level arm adjustments..... 11
	5.4	Control panel (non-standard configuration) ..... 12
	5.4.1	System state..... 12
	5.4.2	Chair position buttons..... 13
	5.4.3	Initial settings of the chair..... 13
	5.4.4	Initial settings description..... 14
	5.4.5	Chair positions description..... 15
	5.5	Foot control..... 16
	5.6	Junction box..... 16
<b>6</b>	<b>Functions introduction.....</b>	<b>17</b>
	6.1	Valves layout of delivery head..... 17
	6.2	Functions introduction..... 18
	6.3	3-way syringe adjustment..... 21
<b>7</b>	<b>Maintenance and sterilization instructions.....</b>	<b>22</b>
	7.1	Handpiece tubings cleaning & maintenance..... 22
	7.2	Clean HVE & SE valves..... 22
	7.3	Clean dirty collector..... 23
	7.4	Clean the filter..... 23
<b>8</b>	<b>Troubleshooting.....</b>	<b>23</b>

# 1 Introduction







## 1.1 Products information















- **Name:** Delivery System
- **Model:** Claasic200/Beyond400
- **Working conditions:**
  - ① Ambient temperature: 5 °C ~ 40 °C;
  - ② Relative humidity: ≤ 80%;
  - ③ Air pressure: 12.5 psi ~ 15.4 kPa;
  - ④ Nominal Voltage : AC110 V ± 22 V;
  - ⑤ Nominal Frequency: 60 Hz ± 1 Hz;
  - ⑤ Water pressure: 29psi ~ 58psi;
  - ⑦ Input air pressure : 72.5psi ~ 101.5psi, Air flow ≥ 50 L/min.

Unit conversion	
MPa	psi
0.2MPa	29psi
0.4MPa	58psi
0.6MPa	87psi
0.8MPa	116psi

## 1.2 Symbols explanations

Table 1

Symbols	Explanations
 Manufacturer	 EU Representative
 Manufacturing date	 Serial Number
 Handle with Care	 Keep dry

Symbols	Explanations
 <p data-bbox="319 512 625 549">Refer to instructions</p>	 <p data-bbox="969 512 1067 549">Notice</p>
 <p data-bbox="263 742 686 778">Refer to attached document</p>	 <p data-bbox="893 742 1124 778">Backrest Down</p>
 <p data-bbox="316 972 633 1008">Avoid Electric Shock</p>	 <p data-bbox="923 972 1109 1008">Backrest Up</p>
 <p data-bbox="334 1210 610 1247">Ground protection</p>	 <p data-bbox="923 1210 1109 1247">Chair Down</p>
 <p data-bbox="371 1440 573 1476">Setup Button</p>	 <p data-bbox="938 1440 1079 1476">Chair Up</p>
 <p data-bbox="349 1666 595 1702">Spitting position</p>	 <p data-bbox="817 1666 1200 1702">Program Chair Position 1</p>
 <p data-bbox="281 1896 663 1932">Program Chair Position 2</p>	 <p data-bbox="817 1896 1200 1932">Program Chair Position 3</p>

## 2 Specifications

Table 2

Light illuminance	8000-40000 Lux
Max load of delivery head	2.5kg
Ambient temperature	5 °C ~40 °C
Air supply pressure	72.5psi~101.5psi
Water supply pressure	29~58psi

## 3 Application notice

### 3.1 Attentions

**Before operating the unit, please read the manual carefully**

- Input voltage : AC110V, 60Hz.
- Make sure the unit is in good grounding .
- The unit needs professional maintenance..
- All the electrical components and connections should be made by an authorized technician.
- All power and water,air supply must be cut off after work finished every day.
- The equipment should not be operated in the environment of high temperature, high humidity, vibration, flammability, unbalance, or dusty.
- No object can be touched in the unit's working range.
- Do not touch the bulb and the reflector of the dental light when the equipment is working.
- This equipment can not be used in the environment of strong magnetic, electromagnetic.

- The equipment should not be used for purposes other than intended use .
- The water source of the system should be purified tap water, the water used shall conform to the local water standards, water hardness  $\leq 450$  mg/L .
- The compressed air used for the system requires no water, no oil, and no sanitary defects. The air used in dentistry shall comply with local standards.
- Sterilize the water tubings with once a day with standard disinfectant. Water bottles are only available for use with distilled water.
- Exhaust water in the air pressure regulator filter in time.
- Clean or replace water filter core in time.
- The filter should be cleaned every week .
- The power must be cut off when replacing electrical components.
- The power must be cut off before maintenance and cleaning.
- If you want to install functional accessories in the machine, such as scaler, curing light or other accessories ,they must be high quality products that passed the safety certification .
- Transportation, storage environment requirements :
  - a. Ambient temperature range :  $-40 \sim +70^{\circ}$  C,
  - b. Relative humidity range : 20%~90%, Including condensation ,
  - c. Air pressure range : 12.5~15psi.
- Protect against rain and vibration in transportation, handle with care.
- Packaged equipment should be stored indoor with less than 80% relative humidity , non-corrosive gases, and in good ventilation.
- The waste water, waste disposal must meet the local environmental protection requirements.
- The system should be operated by professional dentist and people with training, or under the guidance of professional dentist. The unauthorized, the untrained, and non-professionals are not free to carry out any operations.
- Equipment maintenance must be done by the company's professional technicians, unauthorized dismantling and maintenance may cause fatal harm to the machine, and no longer enjoy the company's warranty service.

### 3.2 Warning Information

- You should read and understand the contents of the instructions carefully before operating the equipment.
- Operation should follow all warnings and cautions on the instrument .
- The power socket cable should be in accordance with the standard configuration and the ground wire must be secure .
- Delivery head shall not be stacked with too heavy items (max load 2.5kg) .
- Air pressure of the system has been set before leaving factory, non-professionals are not free to adjust.
- Turn off the main switch of water, gas, power when get off work every day.
- The handpiece shall supply water only when the foot switch is in the state of water supply. (only for 4-pin handpiece tube)
- Hospitals or individual clinics who use the equipment must be equipped with or connected to an amalgam separation device in the waste discharge system .
- The water and air must be exhausted and then cut off the water source and electricity when maintaining or repairing; switch on the power, water and air before the use.
- The 3-way syringe handle and syringe tip should be put into the disinfection bag to disinfect, and then 134 °C (pressure 29.8psi) high pressure steam disinfection, disinfection time is no less than 3 minutes.
- Please read the user's guide before cleaning and disinfecting the high speed turbine and pneumatic micromotor.
- The cover clean with wet cloth and neutral detergent to ensure smooth and elastic leather surface free from corrosion; ABS parts clean with a soft cloth dampened with soap water; the metal baking parts wash with soft cloth dipped in soapy water or wipe with a wax spray.
- Take an extra care with a fiber-optic handpiece to avoid damaging the shining tip and make sure the tip will not come into contact with the treated mixture, keep a certain distance or use a transparent sheet before the first 5 seconds of treatment.
- Any traces left by the mixture on the tool must be removed immediately, remove the fiber-optic handpiece and clean it with a cloth dipped in alcohol.
- Don't point the light of the fiber-optic handpiece to the patient's eyes for the light may harm to patient's eyes,even cause temporary blindness!



## 4 Sizes(unit:inches)

### Classic 200

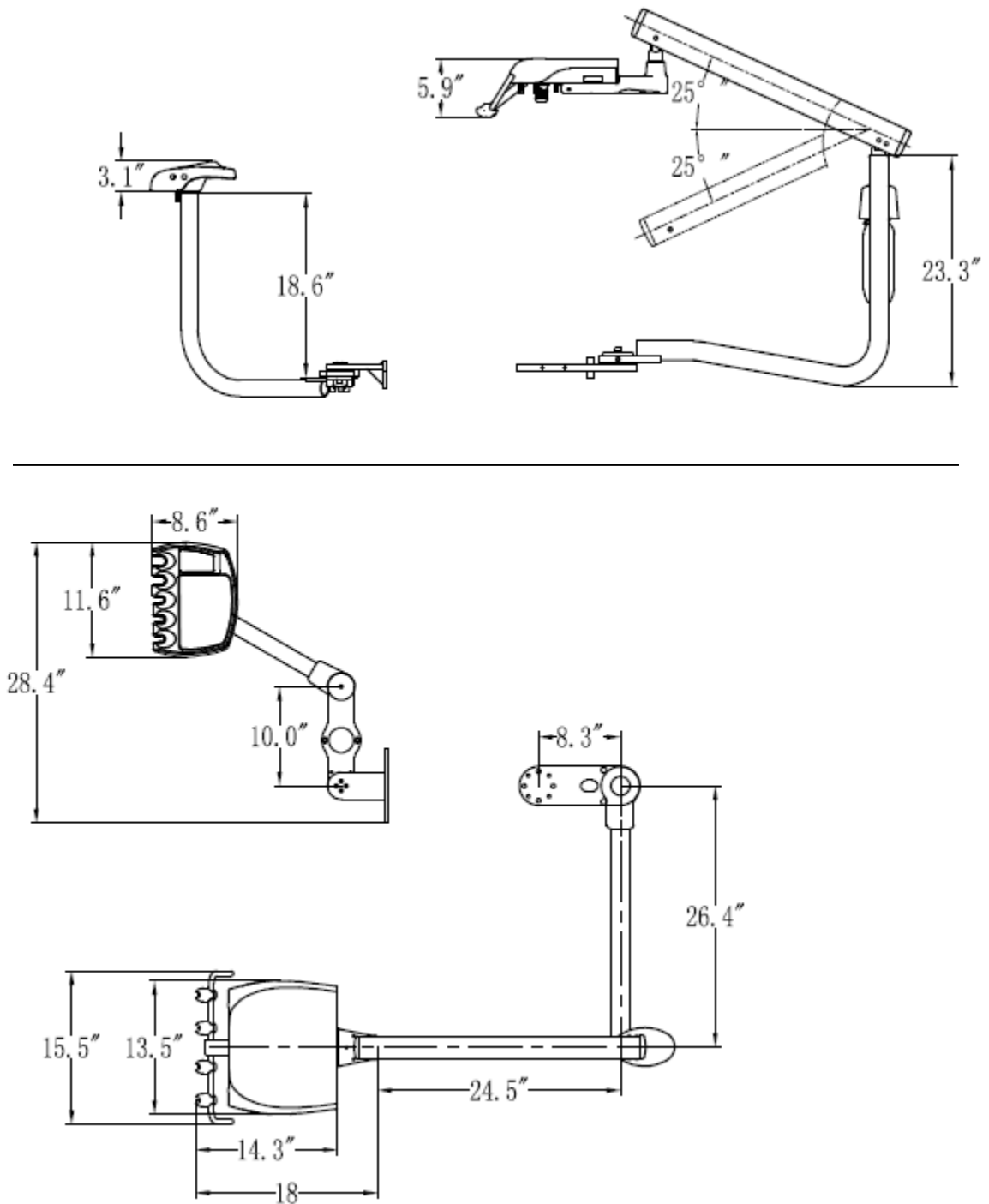

**Beyond 400**

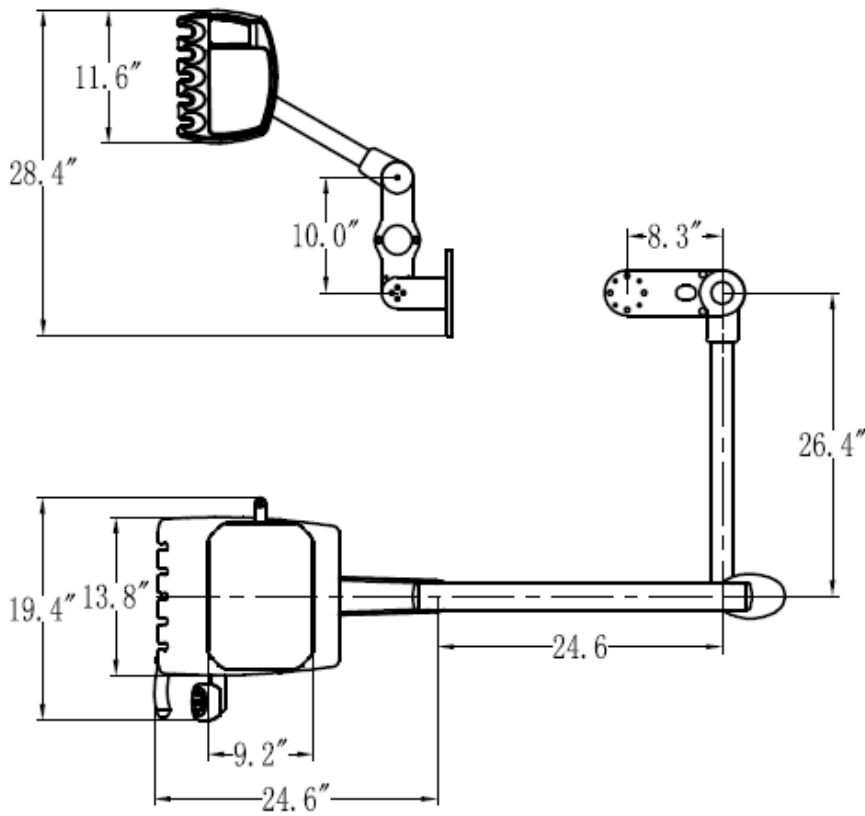
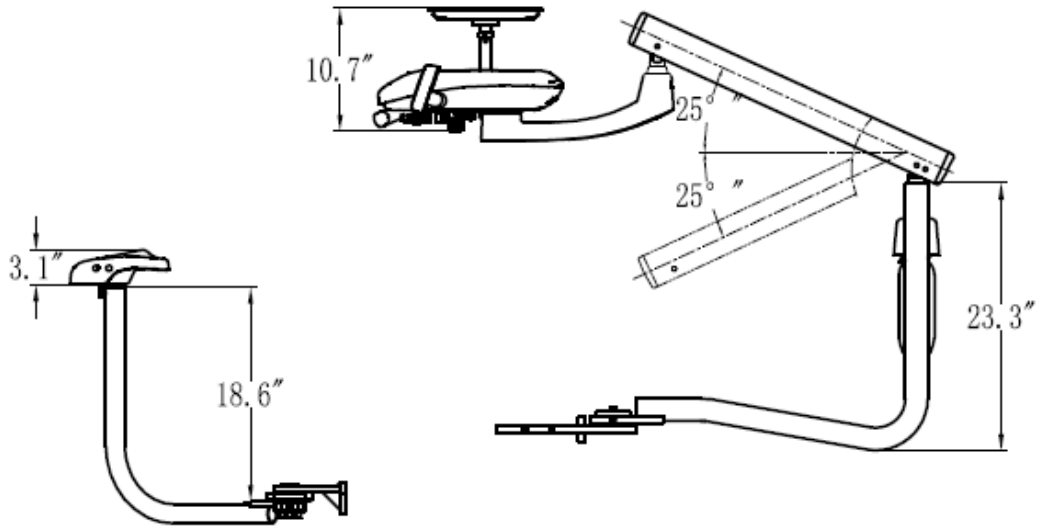

## 5 Operations

### 5.1 Water supply system

A 1.5 L quick-disconnect water bottle mounted on the front rotary arm ,provide simple and convenient solution to control water quality.

- A Air Supply
- B Air pressure adjustment
- C City/Bottle selector

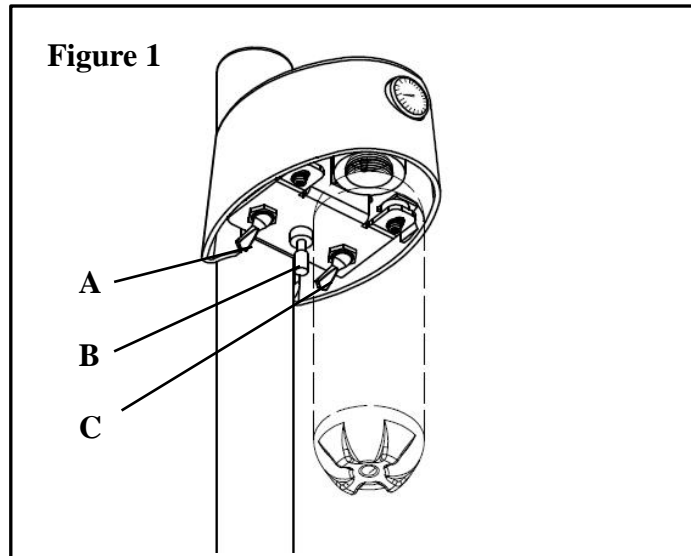

#### Using Bottled Water

1. Turn the Air Supply switch to the OFF position and allow several seconds for air pressure to be released from the bottle. **Never attempt to unscrew the bottle while it is pressurized!**
2. After relieving pressure, remove the empty bottle and install a full bottle.
3. Turn the Air Supply switch to the ON position and check for leakage at the bottle .



**CAUTION:** Only water bottles supplied by the manufacturer can be used .Do not use soft drink bottles which are thin walled and may rupture when under pressure.



**WARNING:** Do not attempt to adjust the water bottle pressure. Bottle pressure is factory pre-set 40psi.Pressurizing the water bottle over 40 psi may cause the bottle to rupture.

## 5.2 Assistant's control

The assistant's control can rotate as the figure shown.

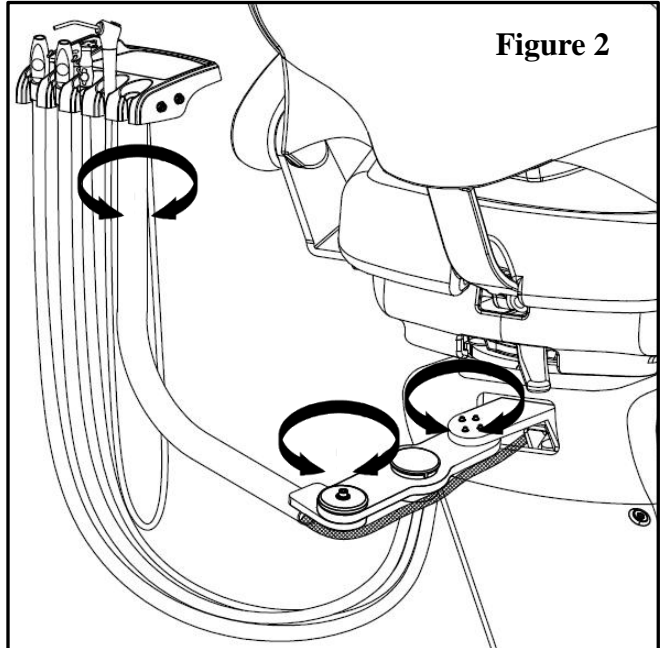

A. Water Q/D: This water output provides 40 psi output to run accessories for the user. Accepts a 1/4" male quick-disconnect fitting.

B. Air Q/D: This air output provides 80 psi output to run accessories for the user. Accepts a 3/8" male quick-disconnect fitting.

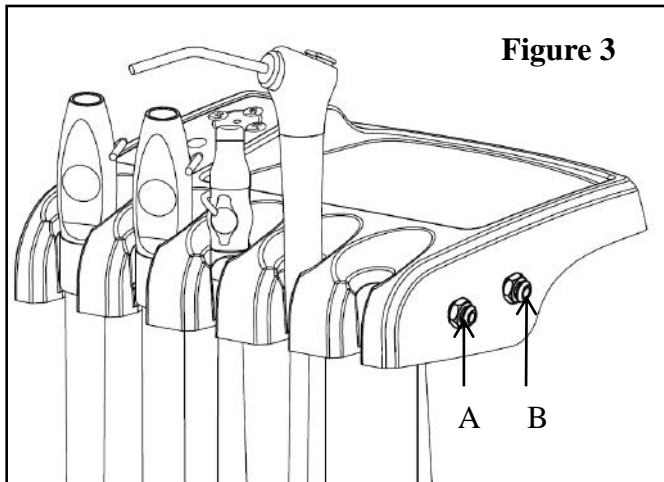

### 5.3 Dentist unit

Classic 200 front mounted dentist unit can rotate as the figure shown .

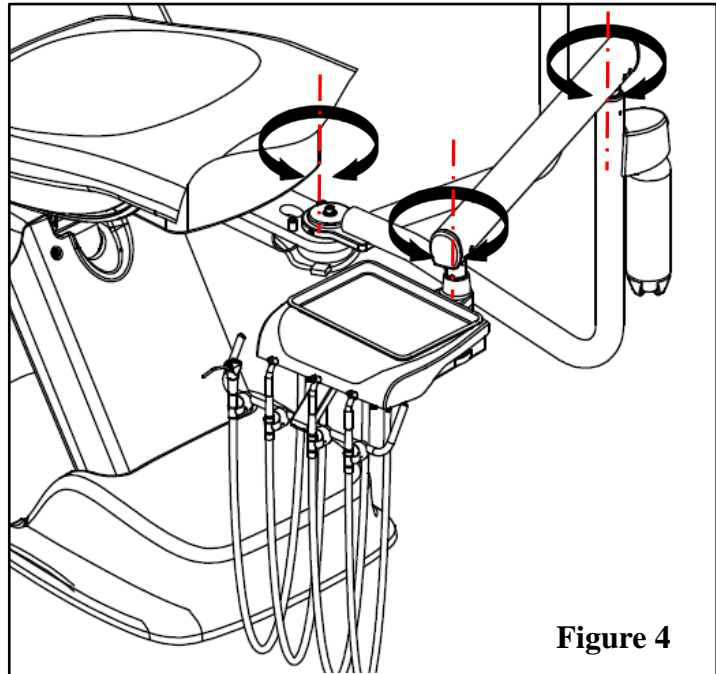

Figure 4

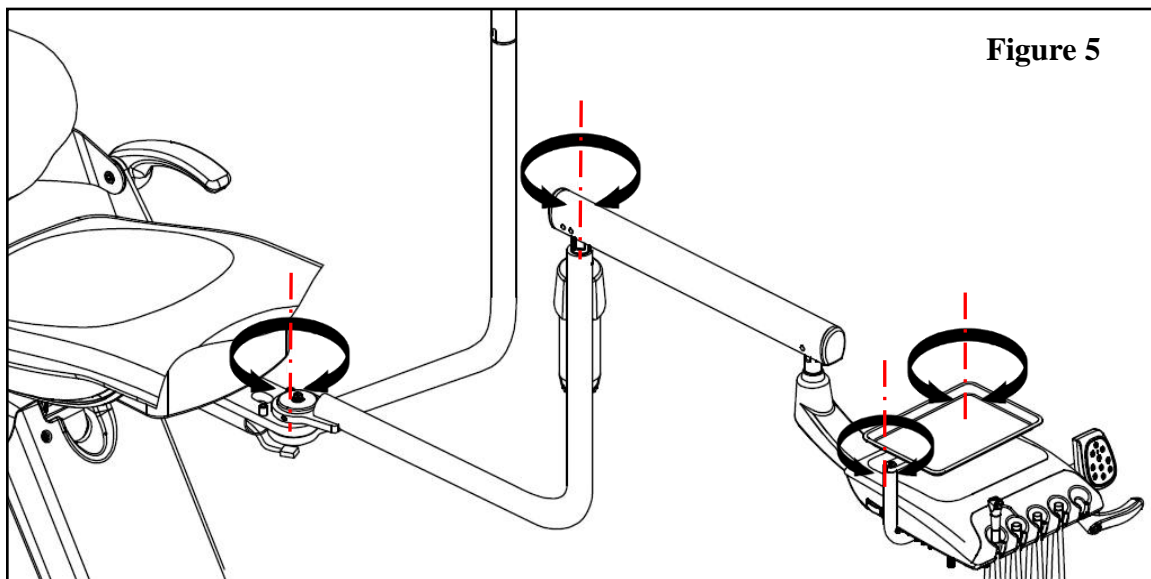

Figure 5

Beyond 400 front mounted dentist unit can rotate as the figure shown .

### 5.3.1 Level arm adjustments

1. Remove the screw caps, change the tightness of the three screws to adjust the damping force of level arm.

**Note:** Loosen the screws in counterclockwise, tighten in clockwise.

**Tools:**  
3mm Allen wrench

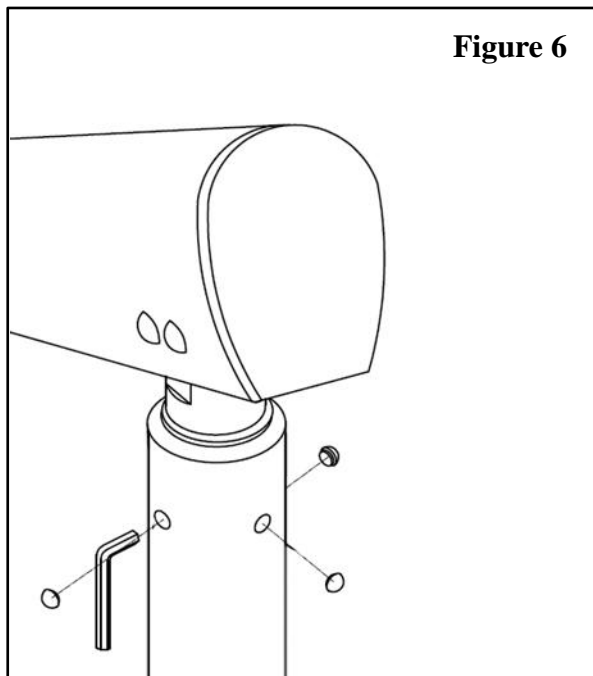

2. Remove the end cover of level arm, adjust the tightness of the screw to get suitable balance force.

**Note:** Loosen the screws in counterclockwise, tighten in clockwise.

**Tools:**  
5mm Allen wrench

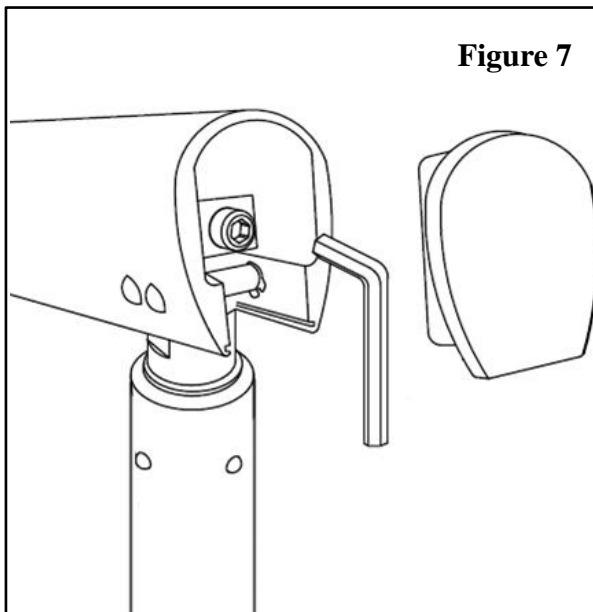

## 5.4 Control panel (non-standard configuration)

Figure 8

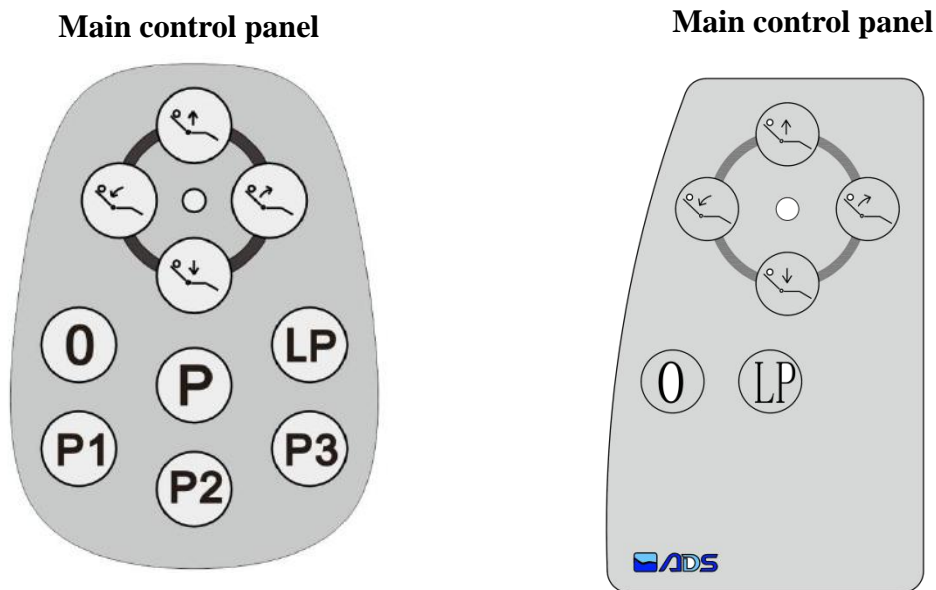











**Note:** The control panels are standard configuration to Beyond 400 system, but optional to Classic 200 system.

### 5.4.1 System state

The light-on of control panel indicates a normal working state, and you can operate normally

### 5.4.2 Chair position buttons

Symbols	Functions	Symbols	Functions
	Backrest Up		Set
	Backrest Down		Spitting position
	Chair Down		Program Chair Positions 1
	Chair up		Program Chair Positions 1
	Original position		Program Chair Positions 1

### 5.4.3 Initial settings of the chair

**Notice:** The hydraulic system shall have the initial setting of the chair in following situations:

**First installation or replacement of mainboard**

**Insert/replace/repair any position feedback potentiometer or wiring**

**Reset or replace the limit switch.**

**Reset the motion range of the chair.**

**Caution :** When setting up the system, do not extent the maximum range of the cylinder to prevent the hydraulic pump from working improperly!



**Hydraulic system initial settings specification:**

1. Press “P” button about 12 second until the buzzer sound 2 short beeps (the indicator flashes twice and then illuminates),enter initial setup state; press P1,the buzzer sound 1short beep( P light off),escape setup state.

This step eliminates the former stroke parameters。

2. Press “O” button about 12 seconds until the buzzer sound 2 short beeps, (the indicator flashes twice and then illuminates),enter initial setup state, move the chair by pressing the four direction buttons to make chair down and backrest up. Then press “O”button , and move the chair again to make chair up to the highest and backrest down to the lowest. A t this time, press “LP” and then finish the setting.

**5.4.4 Initial settings description**



- Move the chair and backrest to the working position, and adjust dental light to the desired condition ( On or Off), press the “P” button (3s) , the indicator light is on (beep 1 time) , ( loose button so as not to enter the original setting state) , enters the setup procedure.
- Press the “P1” button , and then press the “P “button one time again,(beep1-2times), setup finished and escape the setup procedure.
- P2, P3 position setup are same step as the P1.

## 5.4.5 Chair positions description

### . Backrest Up



Press this button continuously and the backrest will move upwards. When the backrest reach the desired position, stop pressing the button and the backrest will stop immediately.

**NOTE: If you press the button continuously, when the chair backrest reach the limit position, it will automatically stop the movement.**

### . Backrest Down



Press this button continuously and the backrest will move downwards. When the backrest reach the desired position, stop pressing the button and the backrest will stop immediately.

**NOTE: If you press the button continuously, when the chair backrest reach the limit position, it will automatically stop the movement.**

### . Chair up



Press this button continuously and the chair will move upwards. When the backrest reach the desired position, stop pressing the button and the backrest will stop immediately.

**NOTE: If you press the button continuously, when the chair backrest reach the limit position, it will automatically stop the movement.**

### . Chair down



Press this button continuously and the chair will move downwards. When the backrest reach the desired position, stop pressing the button and the backrest will stop immediately.

**NOTE: If you press the button continuously, when the chair backrest reach the limit position, it will automatically stop the movement.**

**. Original position**



Press the button, the chair and backrest will move to the original position automatically(Original position : backrest highest , the chair lowest) and light off . Press this button again , the chair returns to former position and light on. The chair shall stop at a new position by halfway stop.

**. Spitting button**



Press the button, the chair and backrest will move to spitting position automatically(Spitting position : backrest highest , the chair is still) and light off . Press this button again , the chair returns to former position and light on. The chair shall stop at a new position by halfway stop.

**5.5 Foot control**

- To close the water coolant, please put the toggle to the left position.
- To open the water coolant, please put the toggle to the right position.

**Figure 9**



**5.6 Junction box**

**Water,air, electric pipelines and the globe valve**

The manual disconnect valve is used for controlling the flow of gas and water to the delivery head. To prevent leakage, these valves should remain fully open (rotating counterclockwise), except for maintenance. Air and water flow through their filters and into the regulator. Please replace these filters when they are blocked and restricted.

## 6 Functions introduction

### 6.1 Valves layout of delivery head

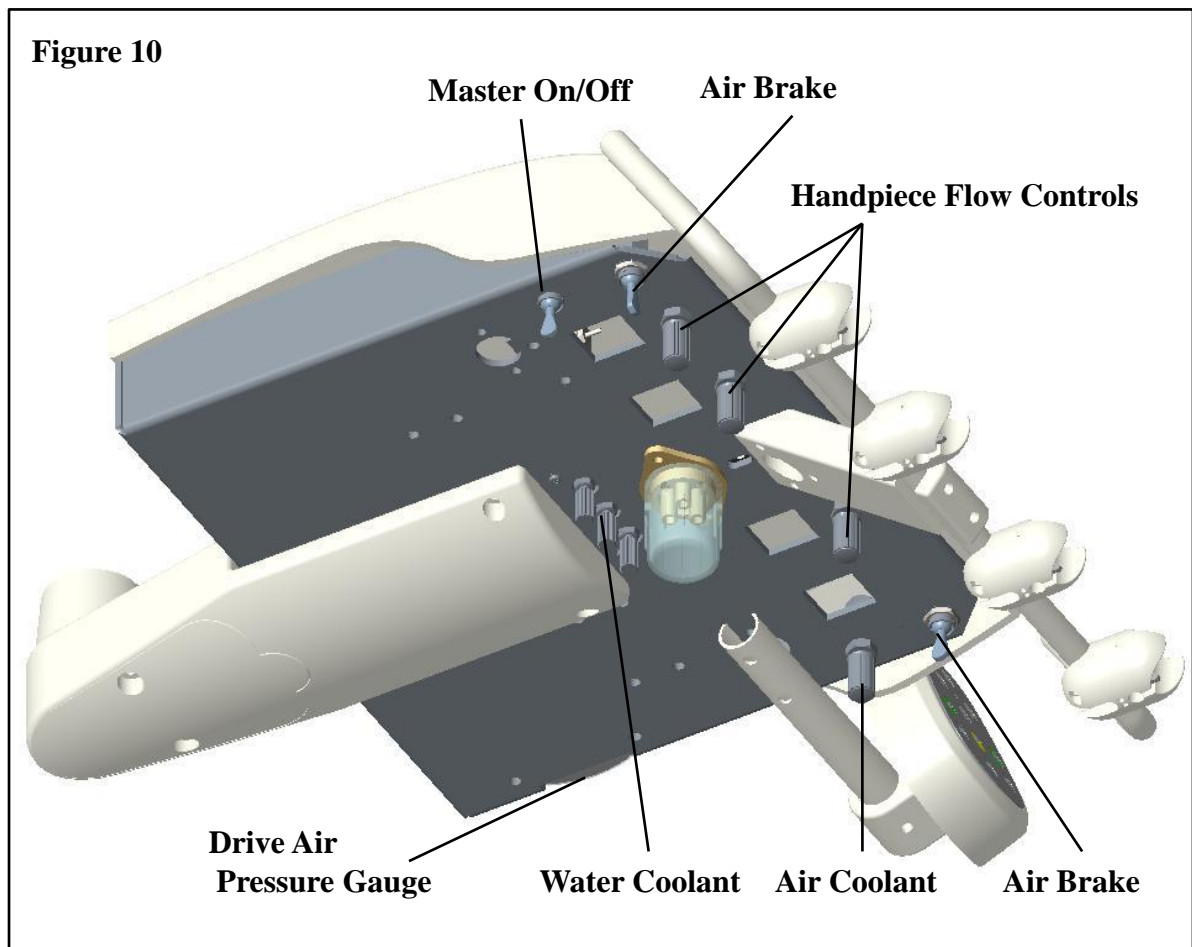

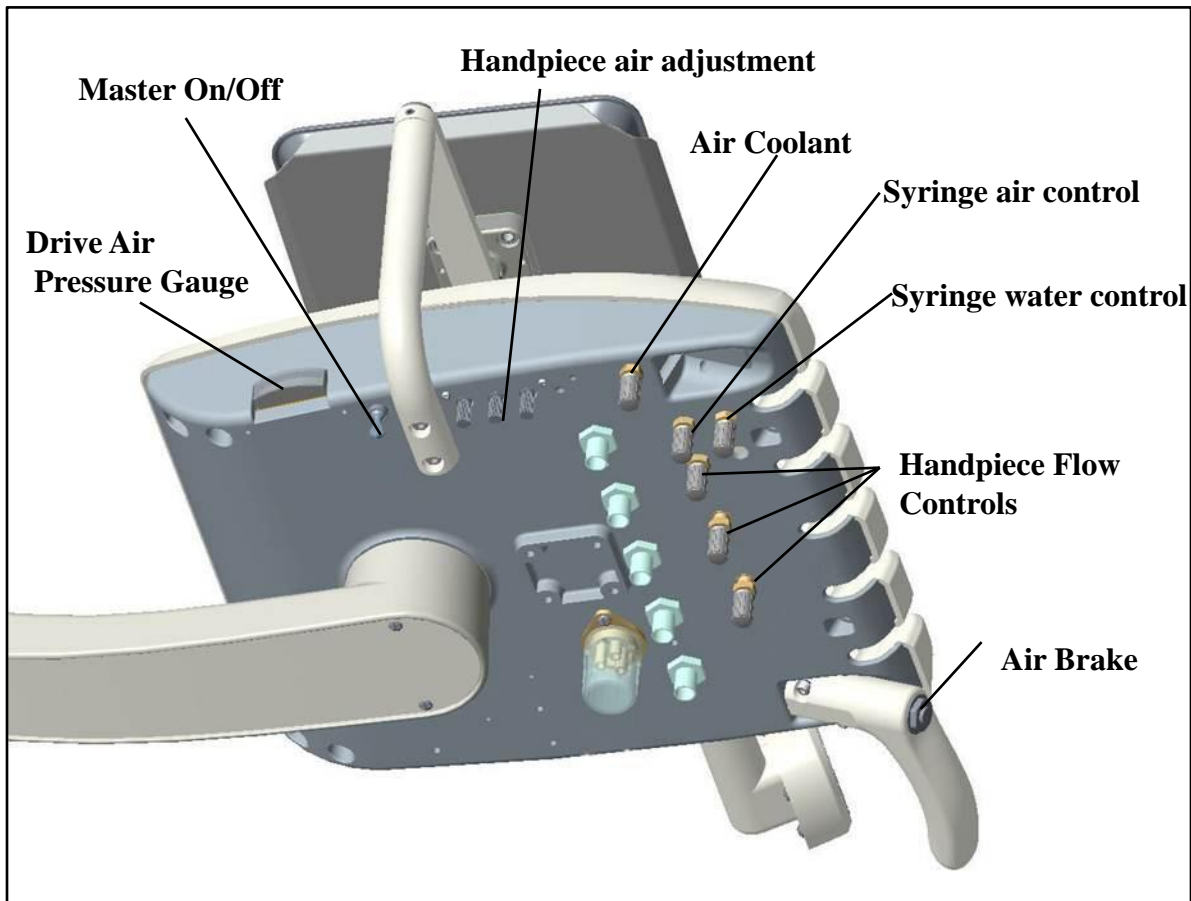

## 6.2 Functions introduction

**Master On/Off:** this toggle switch activater the air and water shut-off valves, which control the air and water supplies to the unit.

Air Coolant:

- ① Take off the handpiece from the holder.
- ② Find the controller of air coolant.
- ③ Step on the foot control to start the handpiece.
- ④ Adjust the air coolant, to the ideal atomization effect as the standard.

Rotate in counterclockwise to increase flow, clockwise to decrease flow.

## Handpiece Flow Controls:

- ① Take off the handpiece from the holder.
- ② Find the controller of air coolant.
- ③ Open the cooling water (open the water/no water state valve on the pedal control board).
- ④ Step on the pedal control board to start the handpiece.
- ⑤ Adjust the cooling water flow.

Rotate the control valve counterclockwise to increase water coolant, clockwise to decrease water coolant.

## Air Brake:

These momentary toggles activate and release the pneumatic brake in the flex arm.

**Syringe air control:** Turn on the switch on the syringe and rotate this valve counterclockwise to increase flow, rotate clockwise to decrease flow.

**Syringe water control:** Turn on the switch on the syringe and rotate this valve counterclockwise to increase flow, rotate clockwise to decrease flow.



**CAUTION:** Only use water bottles supplied by the manufacturer. Do not use soft drink bottles which are thin walled and may rupture when under pressure.



**CAUTION:** Avoid operating the handpieces for extended periods longer than is required to check gauge pressure. Extended operation without load can damage the handpiece. Do not operate the handpiece without a burr in the chuck.

**Figure 12 Handpiece adjustment:**

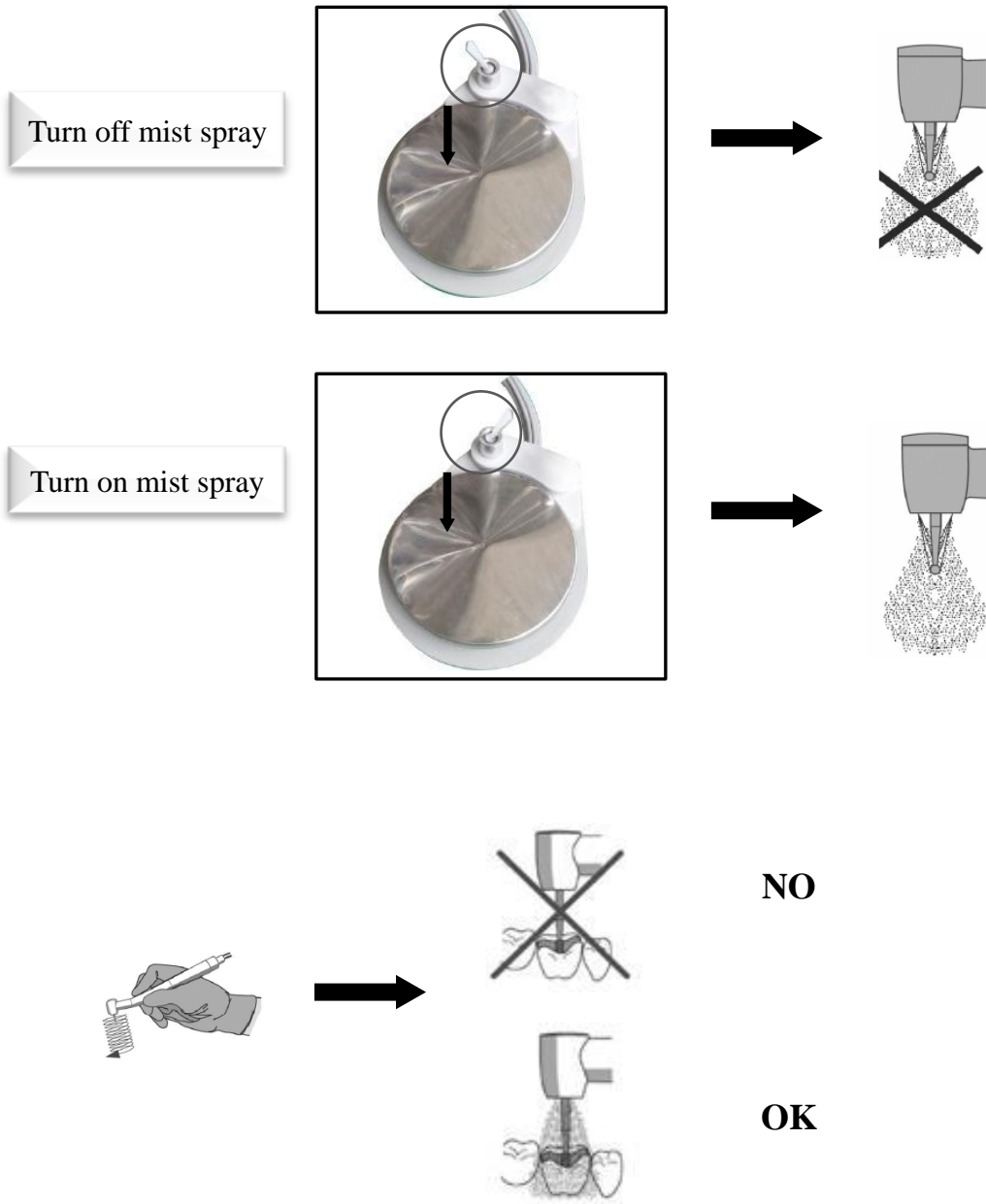

**Note :** Adjust the drive air pressure to meet the demands of handpiece manufacturer's drive air pressure specification. Refer to your handpiece documentation for the drive air pressure specification.

---

### 6.3 3-way syringe adjustment

Figure 13 3-way syringe adjustment

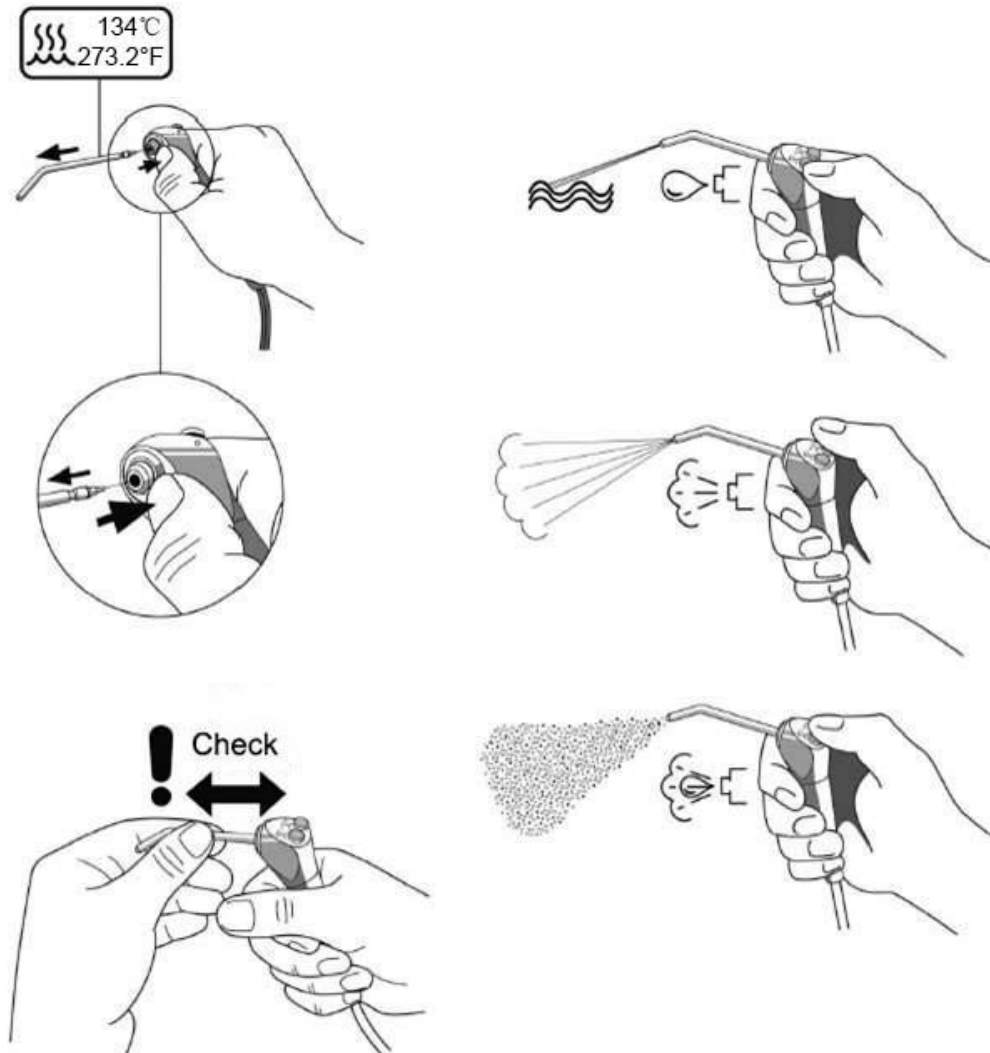



## 7 Maintenance & sterilization instructions

### Touch surface & transfer surface

Touch surface refers to the surface area that need contact in dental treatment while can be potential cross contamination points.

Transfer surface refers to the surface area that contaminated from contacting with the instruments or other inactive object.

ADS company recommends isolating protection for all applicable touch surfaces and transfer surfaces. The partition used must be a plastic film approved the Food & Drug Administration. The plastic films should be taken off and discarded after the treatment of each patient.

### 7.1 Handpiece tubings cleaning & maintenance

#### Flush the tubings independently or together.

After each patient:

1. Disconnect the handpiece before flushing the conduit.
2. Gather handpiece tubings that use water coolant and hold them over a sink, cuspidor bowl, or basin.
3. Hold the tubings so that the water is directed away from you and into the receptacle .(Figure 21.)
4. Flush the tubing continuously about 20~30 min.

Figure 13

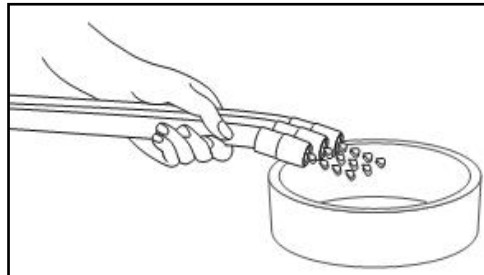

### 7.2 Clean HVE & SE valves

Suggestions:

- Suck 2 cups of fresh water in every two hours during working time;
- Suck 1 liter of water after daily working.

### 7.3 Clean dirty collector

Keep weekly maintenance, increase maintenance times when use frequently .

#### To clean the collector:

- 1.Unscrew the dirty collector counterclockwise and remove it;
- 2.Discard used cotton.
- 3.Put some cotton into dirty collector;
- 4.Tighten the dirty collector clockwise.

Figure 14



### 7.4 Clean the filter

The filter aids in preventing solids from entering the suction system . To ensure a good working state of the suction system, please clean the filter screen at least twice a week.

#### To clean the filter:

1. Close the suction system.
2. Pull out the filter ,remove the filter screen and clean the solids.
3. Reinstall the filter.

Figure 15

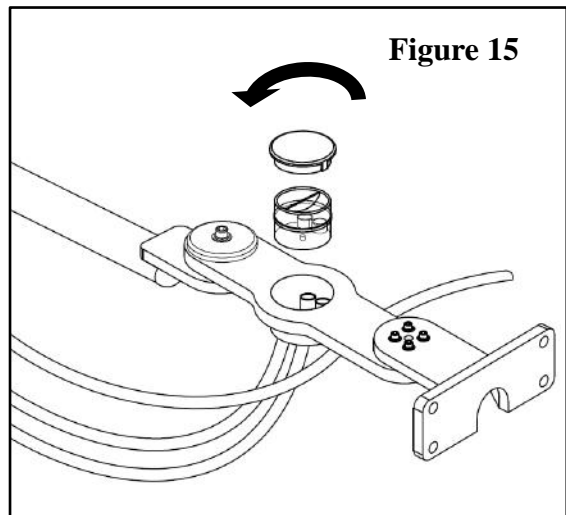

## 8 Troubleshooting

**Please contact your local dealer for help if there is malfunction occurred in your system.**

We reserve the right to make any alterations which may be due to technical improvements.



## ADS Dental System Inc.

---

Add: 1590 S Milliken Ave., unit A, Ontario, CA 91761

Tel: (626) 620 0456

E-mail: [ads@adsequip.com](mailto:ads@adsequip.com)

<http://www.adsequip.com/>